



Level



Pressure



Flow



Temperature

Liquid  
Analysis

Registration

Systems  
Components

Services



Solutions

## Technical Information

# Liquipoint FTW33

Conductive measuring technology  
Point level switch for liquids



### Application

The Liquipoint FTW33 is a point level switch for liquids. It is intended for use in pipes and in storage, mixing and process vessels with or without an agitator. Developed and built for the food industry, the FTW33 meets all international hygiene requirements.

It is particularly suited to applications where flush-mounting is necessary.

The Liquipoint FTW33 can be used in process temperatures up to 100 °C (212 °F) with no limits and in cleaning and sterilization processes to 150 °C (302 °F) for 60 minutes.

The Liquipoint FTW33 can also be used for detecting the foam that commonly occurs within the food industry.

### Your benefits





- Flush-mounted, pigging of pipes still possible
- For liquids with an electrical conductivity  $>1 \mu\text{S}/\text{cm}$  or a dielectric constant  $>20$
- Individual adjustment to each medium not necessary
- Buildup compensation ensures reliable switching
- Easy installation thanks to compact design - even in tight conditions or where access is restricted
- Broad range of process connections for installation in new and existing plants
- Robust stainless steel housing, available with M12x1 connector with IP69K type of protection (optional)
- LED display for on-site function check
- Can be cleaned and sterilized in place (CIP/SIP)
- 3A and EHEDG certificates

## Table of contents







<b>Document information</b> .....	<b>3</b>	Materials .....	8
Document conventions .....	3	<b>Operability</b> .....	<b>9</b>
<b>Function and system design</b> .....	<b>4</b>	Light signals .....	9
Measuring principle .....	4	Extended function range .....	9
Measuring system .....	4	Test .....	9
<b>Input</b> .....	<b>4</b>	<b>Certificates and approvals</b> .....	<b>10</b>
Measured variable .....	4	CE mark .....	10
Measuring range .....	4	Hygienic compatibility .....	10
<b>Output</b> .....	<b>4</b>	Inspection certificates .....	10
DC-PNP switching output .....	4	<b>Ordering information</b> .....	<b>10</b>
<b>Power supply</b> .....	<b>5</b>	Product Configurator .....	10
Supply voltage .....	5	<b>Accessories</b> .....	<b>11</b>
Power consumption .....	5	Process adapter .....	11
Current consumption .....	5	Weld-in adapter .....	11
Electrical connection .....	5	DIN11851 thread adapter nut .....	11
Cable specification .....	5	Cable, plug-in jack .....	11
Overvoltage protection .....	5	<b>Documentation</b> .....	<b>12</b>
<b>Performance characteristics</b> .....	<b>5</b>	Operating Instructions .....	12
Reference operating conditions .....	5	Technical Information .....	12
Measured error .....	5	Supplementary documentation .....	12
Hysteresis .....	6		
Non-repeatability .....	6		
Temperature effect .....	6		
Switching delay .....	6		
Switch-on delay .....	6		
<b>Installation</b> .....	<b>6</b>		
Orientation .....	6		
Connecting cable length .....	6		
<b>Environment</b> .....	<b>6</b>		
Ambient temperature range .....	6		
Storage temperature .....	6		
Climate class .....	6		
Altitude .....	6		
Degree of protection .....	6		
Shock resistance .....	6		
Vibration resistance .....	6		
Cleaning .....	7		
Electromagnetic compatibility .....	7		
Reverse polarity protection .....	7		
<b>Process</b> .....	<b>7</b>		
Process temperature range .....	7		
Process pressure range .....	7		
State of aggregation .....	7		
Function range .....	7		
<b>Mechanical construction</b> .....	<b>8</b>		
Weight .....	8		

## Document information

### Document conventions

Symbol	Meaning
 <small>A0011189-EN</small>	<b>DANGER!</b> This symbol alerts you to a dangerous situation. Failure to avoid this situation will result in serious or fatal injury.
 <small>A0011190-EN</small>	<b>WARNING!</b> This symbol alerts you to a dangerous situation. Failure to avoid this situation can result in serious or fatal injury.
 <small>A0011191-EN</small>	<b>CAUTION!</b> This symbol alerts you to a dangerous situation. Failure to avoid this situation can result in minor or medium injury.
 <small>A0011192-EN</small>	<b>NOTICE!</b> This symbol contains information on procedures and other facts which do not result in personal injury.

### Symbols for certain types of information

Symbol	Meaning
 <small>A0011182</small>	<b>Allowed</b> Indicates procedures, processes or actions that are allowed.
 <small>A0011183</small>	<b>Preferred</b> Indicates procedures, processes or actions that are preferred.
 <small>A0011193</small>	<b>Tip</b> Indicates additional information.
 <small>A0015483</small>	<b>Reference to documentation</b> Refers to the corresponding device documentation.
 <small>A0011195</small>	<b>Reference to page</b> Refers to the corresponding page number.
 <small>A0011196</small>	<b>Reference to graphic</b> Refers to the corresponding graphic number and page number.
	<b>Result of a sequence of actions</b>

### Symbols in graphics

Symbol	Meaning
1, 2, 3 ...	Item numbers
A, B, C, ...	Views

## Function and system design

### Measuring principle

A low, galvanically isolated AC voltage is applied at the electrode in contact with the process. If conductive liquid comes in contact with the electrode, a measurable current flows and the Liquipoint FTW33 switches. Active buildup compensation ensures reliable switching of the device even if material buildup occurs.

### Measuring system

The measuring system consists of a Liquipoint FTW33 point level switch, e.g. for connection to programmable logic controllers (PLC).

#### Applications:

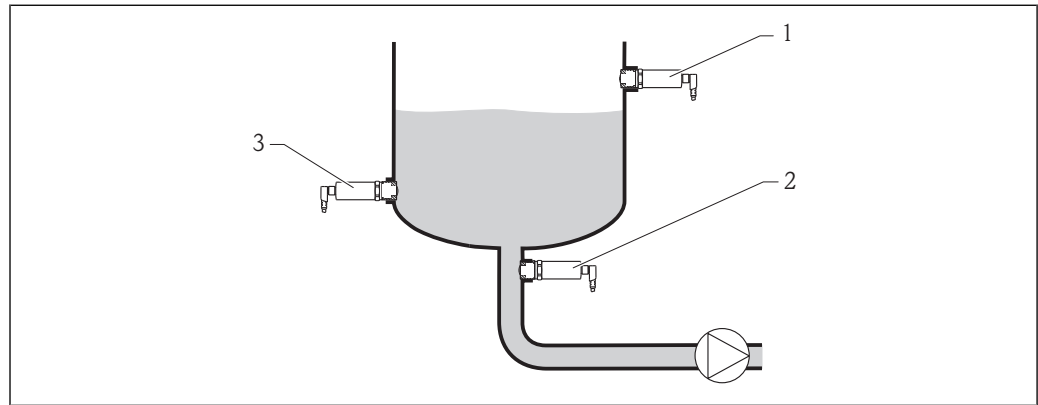

A0016816

- 1 Overfill protection or upper level detection (MAX)
- 2 Pump dry running protection (MIN)
- 3 Lower level detection (MIN)

## Input

### Measured variable

Conductivity at the electrode in contact with the process

### Measuring range

Electrical conductivity of approx. 1  $\mu\text{S}/\text{cm}$  (dielectric constant > 20) to approx. 100  $\text{mS}/\text{cm}$

## Output

### DC-PNP switching output

- Function: positive voltage signal at the switching output of the electronics
- Switching behavior: ON/OFF
- Connectable load: 200 mA (short-circuit proof)
- Safety switching: MIN or MAX point level
  - The electrical switch opens if the point level is reached or if faults or a power outage occur.
    - MAX: e.g. as overfill protection
      - The device keeps the electrical switch closed as long as the level is below the sensor.
    - MIN: e.g. for dry running protection in pumps
      - The device keeps the electrical switch closed as long as the sensor is immersed in liquid.
- Residual voltage: < 3 V
- Residual current: < 100  $\mu\text{A}$

## Power supply

<b>Supply voltage</b>	10 to 30 V DC
<b>Power consumption</b>	< 825 mW (with load)
<b>Current consumption</b>	< 15 mA

**Electrical connection** M12 connector:  
 Supply point: hazardous contact voltage or Class 2 Circuit (North America). The device must be operated with a fine-wire fuse 500 mA (slow-blow).  
 Suitable for use in non-equivalent operation: when both outputs are connected, the MIN and MAX outputs adopt opposite states when the device is operating fault-free. Both electronic switches are open if a fault or cable open circuit occurs. As well as level monitoring, functional monitoring of the sensor is thus also possible by means of two-channel analysis.

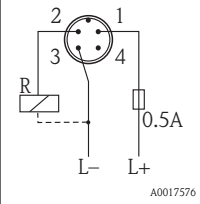
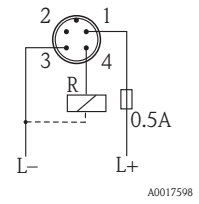
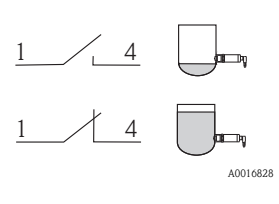
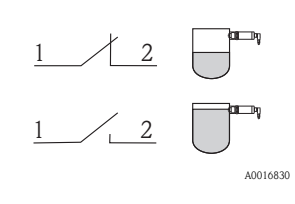
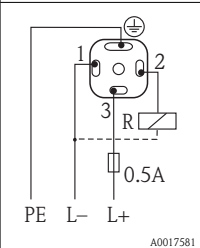
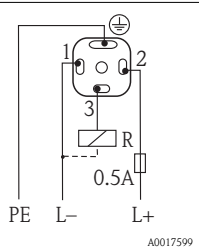
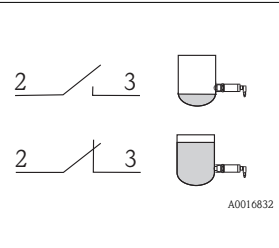
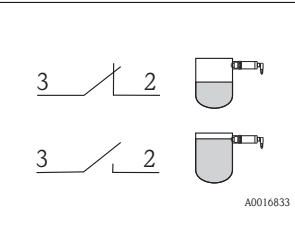
Connector (PIN assignment)		MIN mode (NO Contact)	MAX mode (NC contact)
MAX	MIN		
M12 connector			
			
Valve connector			
			
<ul style="list-style-type: none"> <li>■ I max. 200 mA</li> <li>■ U = 10 - 30 V</li> <li>■ R = external load</li> <li>■ PE = ground</li> </ul>			

**Cable specification** For valve connector: < 1.5 mm<sup>2</sup> (16 AWG) and ø3.5 to 6.5 mm (0.14 to 0.26 in)

**Overvoltage protection** Overvoltage category II

## Performance characteristics

**Reference operating conditions** Horizontal orientation:

- Ambient temperature: 20 °C (68 °F) ±5 °C
- Medium temperature: 20 °C (68 °F) ±5 °C
- Process pressure: 1 bar (14.5 psi)
- Medium: water
- Conductivity: approx. 200 µS/cm

**Measured error** 2 mm (0.08 in) in accordance with DIN 61298-2

<b>Hysteresis</b>	2 mm (0.08 in)
<b>Non-repeatability</b>	1 mm (0.04 in) in accordance with DIN 61298-2
<b>Temperature effect</b>	2 mm (0.08 in) between -40 to +70 °C (-40 to +158 °F)
<b>Switching delay</b>	<ul style="list-style-type: none"> <li>■ When covered: 0.5 s/when free: 1.0 s</li> <li>■ Optional: 0.3 s/1.5 s/5 s</li> </ul>
<b>Switch-on delay</b>	< 1 s (no defined switching status before this)

## Installation

### Orientation

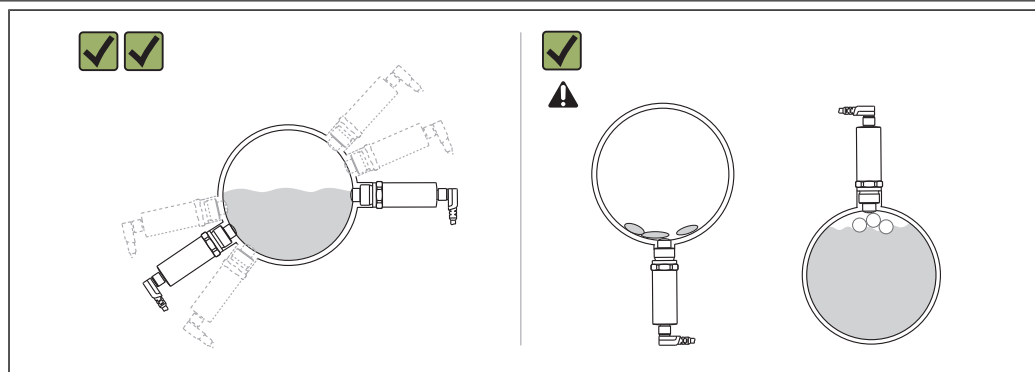

A0016834

### ⚠ CAUTION

#### Vertical orientation can affect the measurement.

It can be influenced by the fact that the sensor is not completely covered with liquid or by air bubbles at the sensor.

- ▶ Ideally, the device should be fitted horizontally or diagonally in a tank or pipe.

<b>Connecting cable length</b>	Max. 25 Ω/wire, total capacity < 100 nF
--------------------------------	---

## Environment



<b>Ambient temperature range</b>	-40 to +70 °C (-40 to +158 °F)
<b>Storage temperature</b>	-40 to +85 °C (-40 to +185 °F)
<b>Climate class</b>	DIN EN 60068-2-38/IEC 68-2-38: test Z/AD
<b>Altitude</b>	Up to 2000 m (6600 ft) above sea level
<b>Degree of protection</b>	<ul style="list-style-type: none"> <li>■ IP65 with valve connector</li> <li>■ IP65/67 with M12x1 connector, plastic</li> <li>■ IP66/68/69K (NEMA4X/6P) with M12x1 connector, metal</li> </ul>
<b>Shock resistance</b>	DIN EN 60068-2-27/IEC 68-2-27: 30 g, 18 ms
<b>Vibration resistance</b>	As per EN 60068-2-64/IEC 68-2-64: 20 to 2000 Hz; 0.01 g <sup>2</sup> /Hz; 3 x 100 min



<b>Cleaning</b>	Resistant to typical cleaning agents from the outside. Passed Ecolab test.
<b>Electromagnetic compatibility</b>	Electromagnetic compatibility in accordance with all of the relevant requirements outlined in the EN 61326 series and NAMUR Recommendation EMC (NE 21). Details are provided in the Declaration of Conformity.
<b>Reverse polarity protection</b>	Integrated

## Process

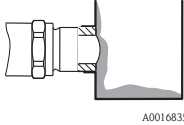
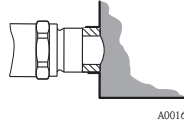
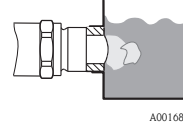
<b>Process temperature range</b>	-20 to +100 °C (-4 to +212 °F) <ul style="list-style-type: none"> <li>■ For 1 hour: +150 °C (+302 °F)</li> <li>■ For 1 hour for M24 process adapter with EPDM process seal: +130 °C (+266 °F)</li> </ul>
<b>Process pressure range</b>	-1 to +25 bar (-14.5 to +362.5 psi)
<b>State of aggregation</b>	Liquid

**Function range** In addition to the standard version, the Liquipoint FTW33 is also available with an extended function range. With the extended version, the operator can choose between standard and extended functions (→  9). This means the device can be perfectly integrated into the relevant process.

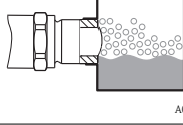
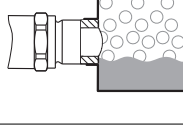
Device version	Process conditions (adhesive and viscous media)		
	Light buildup	Heavy buildup	Surface drying
			
<b>Standard</b> Use for MIN/MAX safety For light buildup at sensor	✓	—	✓
<b>Extended function range</b> Use for MIN safety For heavy buildup at sensor	✓	✓	✓
 Surface drying or insulating layers at the sensor can affect measuring sensitivity and must therefore be avoided or removed.			

Device version	Process conditions (foaming media)	
	Fine-pored	Coarsely pored
		
<b>Standard</b> Use for MIN/MAX safety: foam detection (overflow protection) by sensor	Sensor signal "covered" if foam present	Sensor signal "free" if foam present
<b>Extended function range</b> Use for MIN safety: foam suppression (dry running and pump protection) by sensor	Sensor signal "free" if foam present	Sensor signal "free" if foam present
 Very coarsely-pored foam cannot be detected by the sensor.		

## Mechanical construction

Dimensions in mm (in)

Sensor	Electrical connection							
	M12 connector				Valve connector			
	 A0016840				 A0016842			
	<b>Housing cover</b>							
		M12 plastic		M12 metal		Plastic valve connector		
		 A0016846		 A0016845		 A0016847		
	H1	21 (0.83)		21 (0.83)		16 (0.63)		
	<b>Housing</b>							
		 A0016848						
	H2	58 (2.28)						
	<b>Process connections</b>							
	Clamp		Milk pipe		Thread			
	DN25-38 1 - 1½"	DN40 2"	DN25 PN40	DN40 PN40	G ¾"	G 1"	M24x1.5	G ½" Hygiene adapter
	 A0016849	 A0016850	 A0016851	 A0016852	 A0016853	 A0016776	 A0016854	 A0016855
H3	36 (1.42)				41 (1.61)	43 (1.69)	41 (1.61)	50 (1.97)
H4	-				16 (0.63)	19 (0.75)	13 (0.51)	15 (0.59)
H5	2 (0.08)							

**Weight**                      Approx. 300 g (10.58 oz)

**Materials**                    Material specifications in accordance with AISI and DIN EN.

Materials in contact with process	Materials not in contact with process
Sensor: 316L (1.4404)	Housing: 316L (1.4404)
Sensor insulation: PEEK	Housing covers:
Metallic surface in contact with process: Ra ≤0.76 µm (30 µin)	<ul style="list-style-type: none"> <li>■ M12 metal: 316L (1.4404)</li> <li>■ M12 plastic: PPSU</li> <li>■ Valve connector, plastic: PPSU</li> <li>■ Design ring: PBT/PC</li> </ul>
Seals:	Nameplate:
<ul style="list-style-type: none"> <li>■ For process adapter with M24 thread: EPDM</li> <li>■ For weld-in adapter with G ¾", G 1": VMQ</li> </ul>	<ul style="list-style-type: none"> <li>■ Plastic foil (attached to housing)</li> <li>■ Lasered (on housing, M12 metal (IP69K))</li> </ul>



- i** Endress+Hauser supplies DIN/EN process connections with threaded connection in stainless steel in accordance with AISI 316L (DIN/EN material number 1.4404 or 1.4435). With regard to their stability-temperature property, the materials 1.4404 and 1.4435 are grouped together under 13E0 in EN 1092-1, Tab. 18. The chemical composition of the two materials can be identical.

## Operability

### Light signals

- i** The light emitting diodes (LEDs) are only available for device versions with a plastic connector cap.

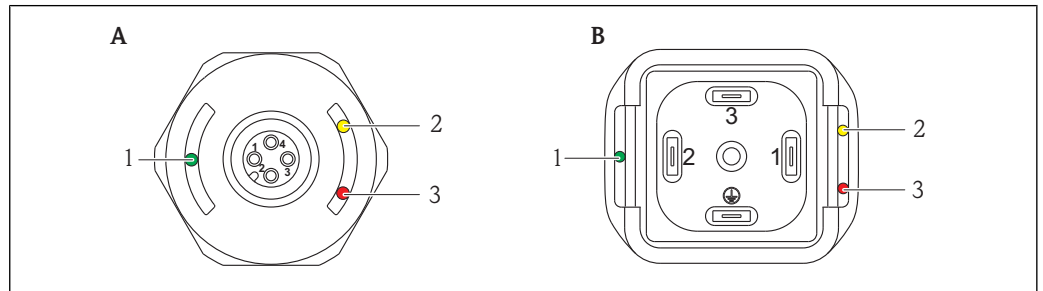

- A M12 connector  
 B Valve connector  
 1 Green LED (gn) → Operating status  
 2 Yellow LED (ye) → Operating mode  
 3 Red LED (rd) → Warning or fault

### Extended function range

- i** This function is only available for devices with an extended function range. A switching magnet is part of the scope of delivery.

With the extended function range, the operator can change between extended and standard functions (→ 7).

To do this, the switching magnet is held against the device during device start-up:

- Change between standard and extended: approx. 10 to 15 s
- Change from standard to extended: approx. 30 to 35 s

If the extended function range is active, the green LED flashes after the operating voltage has been applied for 5 seconds (1.5 Hz).

### Test

- i** This function is only available for devices with an extended function range. A switching magnet is part of the scope of delivery.

The switching magnet is held against the device during operation: The device's current switching status is reversed.

## Certificates and approvals

**CE mark** The measuring system is in conformity with the statutory requirements of the applicable EC Directives. These are listed in the corresponding EC Declaration of Conformity along with the standards applied.  
Endress+Hauser confirms successful testing of the device by affixing to it the CE mark.

**Hygienic compatibility** The Liquipoint FTW33 was developed for use in hygienic processes. Materials in contact with the process meet FDA requirements as well as 3A Sanitary Standard No. 74. The 3A symbol is attached to the device by Endress+Hauser to confirm this.

The following certificates can be ordered with the device (optional):

- 3A
- EHEDG



A0016869



A0016862

**i** The seamless connections can be cleaned of all residue using any of the typical cleaning methods within this industry.

**Inspection certificates** The following documents can be ordered with the device (optional):

- Acceptance test certificate as per EN 10204-3.1
- Test report of surface roughness ISO4287/Ra
- Final inspection report

## Ordering information

**Product Configurator** **i** Product Configurator - the tool for individual product configuration

Detailed ordering information is available from the following sources:

- In the Product Configurator on the Endress+Hauser website: [www.endress.com](http://www.endress.com) → Select country → Instruments → Select device → Product page function: Configure this product
- From your Endress+Hauser Sales Center: [www.endress.com/worldwide](http://www.endress.com/worldwide)
- Up-to-the-minute configuration data
- Depending on the device: Direct input of measuring point-specific information such as measuring range or operating language
- Automatic verification of exclusion criteria
- Automatic creation of the order code and its breakdown in PDF or Excel output format
- Ability to order directly in the Endress+Hauser Online Shop

## Accessories

 The adapters are supplied with or without acceptance test certificate EN 10204-3.1 and can also be ordered with the device (optional).

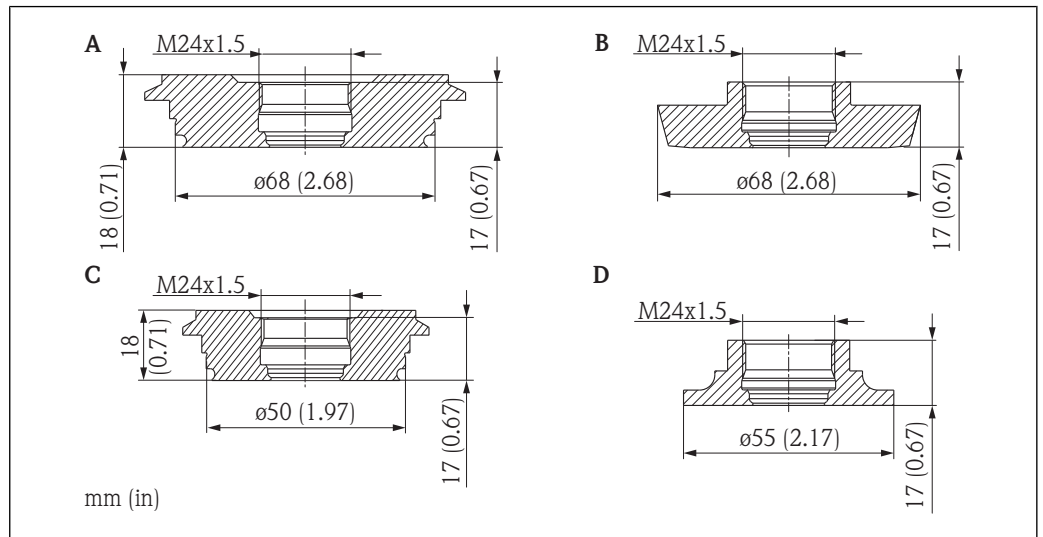

### Process adapter



A0016863

- A Varivent N, 316L (1.4435)
- B DIN11851 DN50, 316L (1.4435)
- C Varivent F, 316L (1.4435)
- D SMS 1 1/2", 316L (1.4435)

### Weld-in adapter

G 3/4"	G 1"	M24
d=50	d=60	d=65
d=29	d=53	
Material: 316L (1.4435)		
 Please refer to the supplementary documentation for further information (→  12)		

### DIN11851 thread adapter nut For process connections:

Milk pipe DN50	Milk pipe DN40	Milk pipe DN25
F50	F40	F25
Material: 304 (1.4307)		

### Cable, plug-in jack

<b>Designation</b>	<b>4 x 0.34 M12 box</b>		<b>4 x 0.34 M12 box with integrated LEDs</b>
Order number	52010285	52024216	52018763
Cable	PVC (gray) 5 m (16 ft)	PVC (orange) 5 m (16 ft)	PVC (orange) 5 m (16 ft)
Handle	PUR (blue)	PVC (orange)	PVC (transparent)
Thread adapter nut	Cu Sn/Ni	316L (1.4435)	316L (1.4435)
Degree of protection	IP67	IP69K (fully locked)	IP69K (fully locked)
Temperature range	-25 to +70 °C (-13 to +158 °F)		

A0016864

---

## Documentation



The following document types are also available in the Download Area of the Endress+Hauser web site: [www.endress.com](http://www.endress.com) → Download

---

<b>Operating Instructions</b>	Liquipoint FTW33 → BA00418F/00/A6
<b>Technical Information</b>	Weld-in adapter → TI00426F/00/EN
<b>Supplementary documentation</b>	<ul style="list-style-type: none"><li>■ Weld-in adapter G 1", G ¾" → SD00352F/00/A6</li><li>■ Weld-in adapter M24 → BA00361F/00/A6</li></ul>

---

### Instruments International

Endress+Hauser  
Instruments International AG  
Kaegenstrasse 2  
4153 Reinach  
Switzerland

Tel.+41 61 715 81 00  
Fax+41 61 715 25 00  
[www.endress.com](http://www.endress.com)  
[info@ii.endress.com](mailto:info@ii.endress.com)

Endress + Hauser 

People for Process Automation

