

▶▶ IP-66 SERIES PRODUCTS

▶ IP66 R-Box, 6 Modules

The R-Box is water and dust-proof with its IP66 degree of protection. The two stage opening cover eliminates cable crushes ensuring safety in use. With 6 modules capacity, the R-Box can be customised to meet your needs, and can be used in tabletop, under screed or raised floor applications.

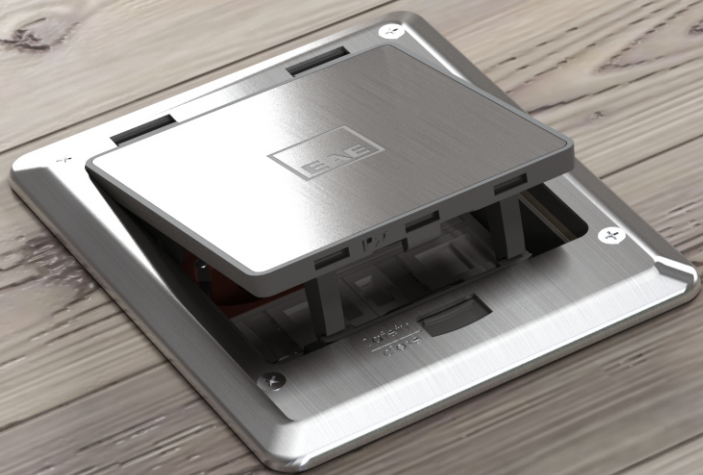

- Two stage opening cover structure
- Plastic socket plate for modular type (45x45mm and 22.5x45mm) power, data, telephone and multimedia outlets
- Suitable structure for underscreed and raised floor application and back box with pipe entry.
- Six (6) modules outlet capacity
- Special locking mechanism on the cover eliminating cable crushes

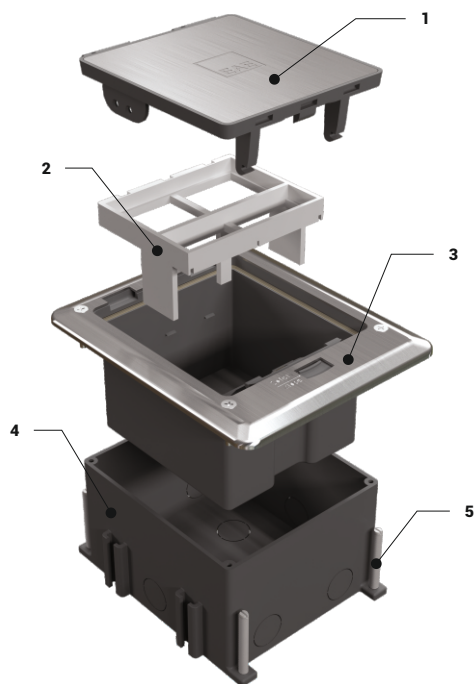

- 1 - Plastic top cover (stainless filler inside of cover)
- 2 - Plastic socket plate (6 modules)
- 3 - IP66 Stainless steel metal frame with plastic rectangular body
- 4 - IP66 Under screed back box
- 5 - Before screed height adjustment screw (0-50mm)

■ Sockets are not included.
Sockets can be ordered by selecting from the table on the back.

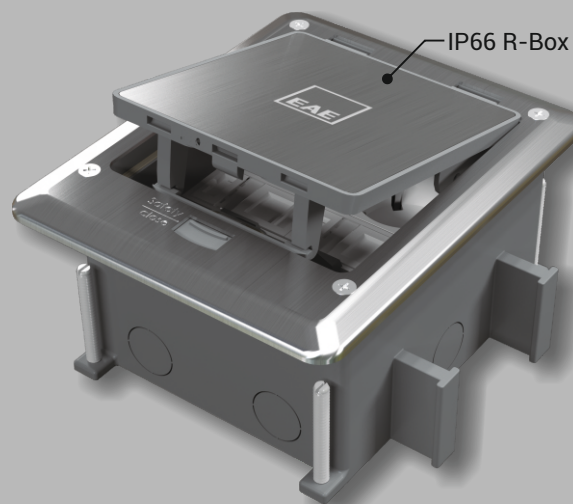

Applications:



Residential Buildings



Shopping Centres



Airports



Factory Workshop



Administrative Buildings Offices



Hotels



Hospitals Health Centres



Sport Centres

►► Order Codes

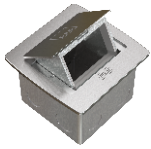

Description	Mechanism	Cut out (mm)	Order Code
P-Box 3M (3 Modules)	Soft	102x105	1022598

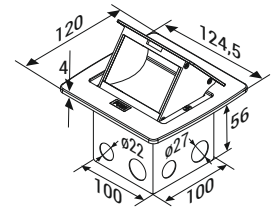
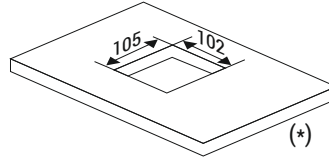

Description	Mechanism	Cut out (mm)	Order Code
P-Box 6M (6 Modules)	Soft	202x105	1022599

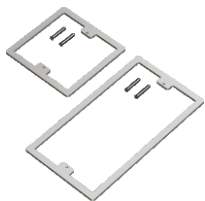
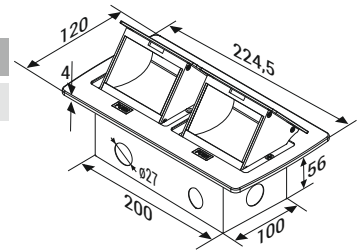
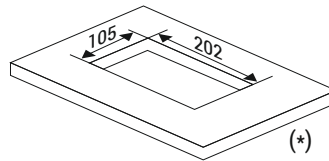

Description	Dimensions (mm)	Order Code
P-Box 3M Desk Support (Stainless)	114x116	2086156
P-Box 6M Desk Support (Stainless)	214x116	2086157

■ Order separately for internal desk and raised covering (built-in) applications.

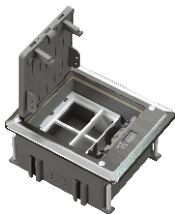
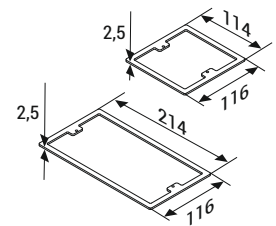

Description	Cut out (mm)	Order Code
IP-66 R-Box (6 Modules)	119x134	1022596

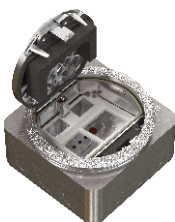
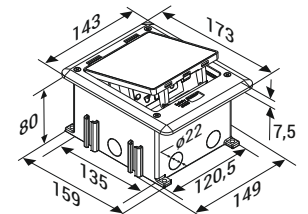
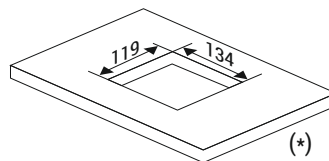

Description	Cut out (mm)	Order Code
IP-66 C-Box (6 Modules)	Ø131	1022597

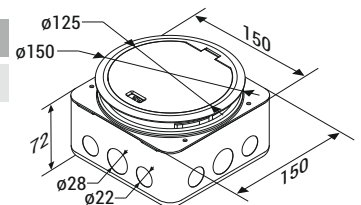
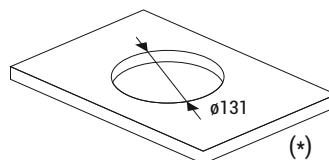

(*) Cutting dimensions for desk or raised covering applications.